

Metallized Polypropylene Film Capacitors (MKP)

Series/Type: YHKC series

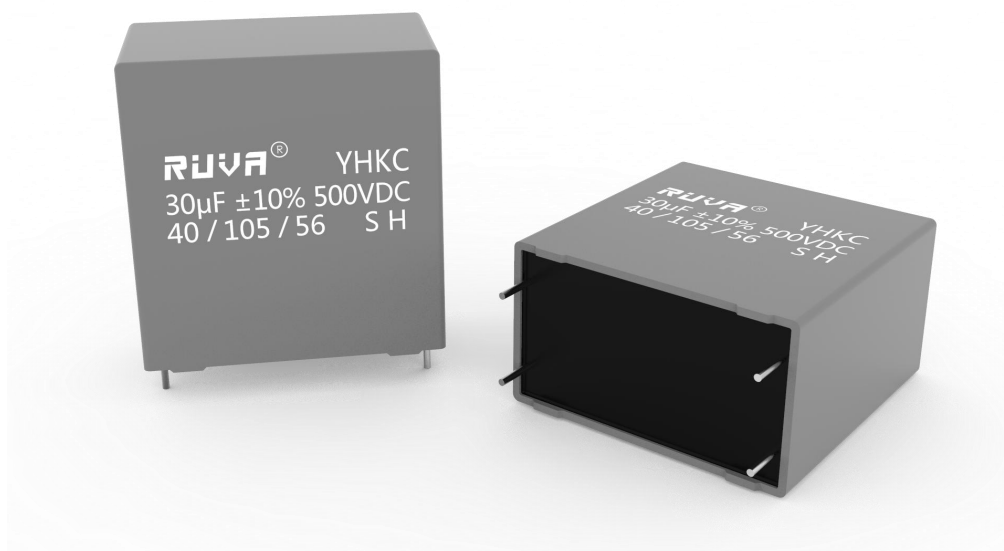

NINGGUO YUHUA ELECTRICAL PRODUCTS CO.,LTD.

Address: No. 31 Zhenning Road, Ningguo City, Anhui Province

Tel: + 86-563-4183768 Fax: + 86-563-4012888

www.ngyh.com Version: Mar.2020

◆ **Applications**

1. Frequency converters
2. Industrial and high-end power supplies
3. Solar Inverters

◆ **Construction**

1. Dielectric: Polypropylene (MKP)
2. PBT Plastic case (UL 94 V-0)
3. Epoxy resin sealing (UL 94 V-0)

◆ **Features**

1. High CV product, compact
2. Good self-healing properties
3. Over-voltage capability
4. Low losses with high current capability
5. High reliability
6. Long useful life
7. RoHS-compatible

◆ **Climatic**

1. Max. operating temperature: 105 °C (case)
2. Climatic category (IEC 60068-1): 40/105/56

◆ **Terminals**

1. Parallel wire leads, lead-free tinned
2. 2-pins, 4-pins, versions
3. Standard lead lengths: 5±1 mm

◆ Outline Drawing

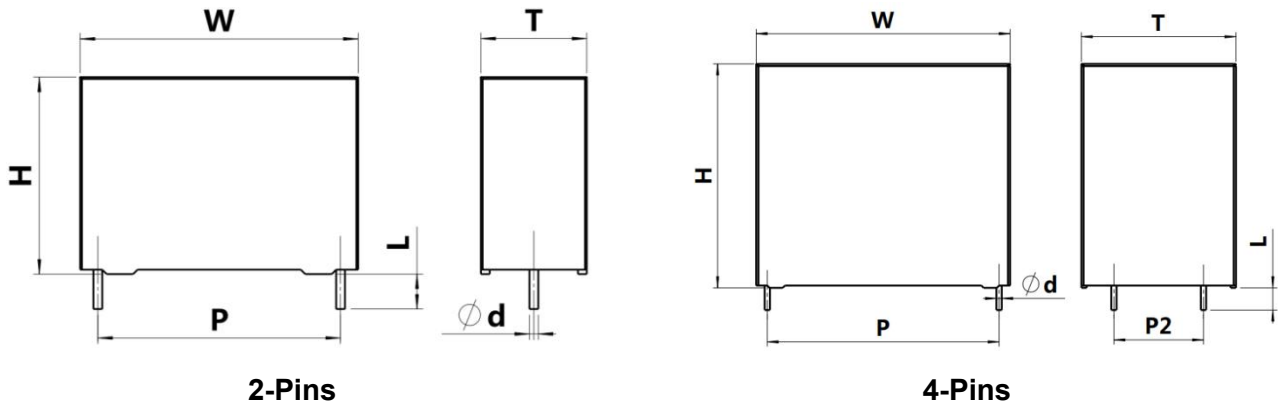

◆ Marking

For example:

RUVA[®] YHKC
 30μF±5% 500VDC
 40/105/56 S H
 L1202001

Symbol	Description	Symbol	Description
RUVA[®]	Brand	YHKC	Specification
30μF±5%	Rated capacitance and tolerance	500VDC	Rated voltage
SH	Self healing marker	L1202001	Production date

◆ Technical data

Reference standard	GB/T 17702-2013(IEC 61071:2007) ; GB/T 2693-2001(IEC 60384-1:2008) ; IEC 60068
Climatic category	40/105/56
Operating temperature range (case)	Max. operating temperature, Top +105°C Lower category temperature T _{min} -40°C
For temperatures between 85 °C and 105 °C	1.33%/°C of V _{op} derating compared to V _{op} @85 °C
Rated voltage (V _R) 85°C	500VDC/600VDC/800VDC/900VDC/1000VDC 1100VDC/1200VDC
Capacitance tolerance	J (±5%) ; K (±10%)
DC test voltage between terminals (10s)	1.5 x V _R
Voltage test terminal to case (10s)	2100 V AC, 50 Hz
Insulation Resistance	> 10 000 s (20°C, 100vdc, 1min)
Maximum peak current	I _P =C*dV/dT
Operation life time	60 000 h at V _R and 85°C

◆ **Typical Waveform**

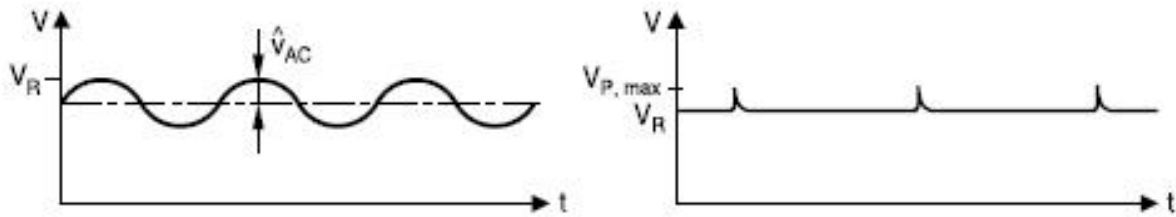

◆ **Restrictions**

V_R : Maximum operating peak voltage of either polarity but of a non-reversing waveform, for which the capacitor has been designed for continuous operation.

$$V_{AC} \leq 0.2 * V_R$$

Overvoltage	Maximum duration within one day	Observation
$1.1 * V_R$	30% of on-load duration	System regulation
$1.15 * V_R$	30 min.	System regulation
$1.2 * V_R$	5 min.	System regulation
$1.3 * V_R$	1 min.	System regulation

NOTE 1

An over voltage equal to $1.5 * V_R$ for 30 ms is permitted 1000 times during the life of the capacitor. The amplitudes of the over voltage that may be tolerated without significant reduction in the life time of the capacitor depend on their duration, the number of application and the capacitor temperature. In addition, these values assume that the over voltage may appear when the internal temperature of the capacitor is less than 0 °C but within the temperature category.

NOTE 2

The average applied voltage must not be higher than the specified voltage

◆ **Part Number Code System**

YHK C 505 P 1200 Z 27 K 050

① ② ③ ④ ⑤ ⑥ ⑦ ⑧ ⑨

1. **Series code**

YHK DC-link series

2. **Internal use**

3. **Rated capacitance value**

For example 505=50*10⁵pF=5.0uF

4. **Internal use**

5. **Rated voltage**

For example 1200=1200Vdc, 0600=600Vdc

6. **Lead diameter**

Z=Φ0.8mm ; H=Φ1.0mm ; E=Φ1.2mm

7. **Lead pitch**

2 pins	27=27.5mm	37=37.5mm	52=52.5mm
4 pins	2A=27.5mm	(P2=10.2mm)	2B=27.5mm (P2=12.7mm)
4 pins	3A=37.5mm	(P2=10.2mm)	3B=37.5mm (P2=12.7mm)
4 pins	3C=37.5mm	(P2=20.3mm)	5C=52.5mm (P2=20.3mm)

8. **Capacitance tolerance**

J=±5% K=±10%

9. **Lead length**

050= 5mm 100=10mm Rxx=Special customization

◆ Parameters and specifications

V _R =500Vdc at 85°C												
C (uF)	W ±1	H ±1	T ±1	P ±0.5	P2 ±0.5	d ±0.05	dV/dt (V/us)	Tgδ*10 ⁻⁴		ESR@10 kHz (mΩ)	I _{rms} (A)	Part number
								1kHz	10kHz			
5	32.0	21.0	11.0	27.5	-	0.8	30	12	120	25	3.0	YHKC505P0500Z27+-000
10	32.0	24.5	15.0	27.5	-	0.8	30	12	120	7.5	6.5	YHKC106P0500Z27+-000
22	32.0	36.5	22.0	27.5	-	1.0	30	12	120	5.0	10.0	YHKC226P0500Z27+-000
30	42.0	40.0	20.0	37.5	10.2	1.0	21	22	220	8.0	12.5	YHKC306P0500H3A+-000
35	42.0	36.0	24.0	37.5	10.2	1.0	21	22	230	8.0	13.5	YHKC356P0500H3A+-000
45	42.0	38.0	28.0	37.5	10.2	1.0	21	25	250	6.0	14.5	YHKC456P0500H3A+-000
55	42.0	45.0	30.0	37.5	20.3	1.2	21	25	250	5.0	16.0	YHKC556P0500E3C+-000
60	42.0	50.0	33.0	37.5	20.3	1.2	21	25	250	4.5	16.5	YHKC556P0500E3C+-000
80	57.5	45.0	30.0	52.5	20.3	1.2	15	35	350	4.0	17.0	YHKC806P0500E5C+-000
110	57.5	50.0	35.0	52.5	20.3	1.2	15	35	350	3.5	18.0	YHKC117P0500E5C+-000

1 "+ -" Means the capacity tolerance can conform to "J"K

2 "000" Means Internal use the lead length

3 Capacitance value measured at 1 kHz

4 Max ripple current I_{RMS} at 85°C, at 10 kHz for a ΔT ≤15 °C at ΔESR_{typ} ≤±5%

5 Typical ESL value measured at resonance frequency

V _R =600Vdc at 85°C												
C (uF)	W ±1	H ±1	T ±1	P ±0.5	P2 ±0.5	d ±0.05	dV/dt V/us)	Tgδ*10 ⁻⁴		ESR@10 kHz (mΩ)	I _{rms} (A)	Part number
								1kHz	10kHz			
2	32.0	18.0	9.0	27.5	-	0.8	30	11	100	45.0	3.0	YHKC205P0600Z27+-000
4	32.0	21.0	11.0	27.5	-	0.8	30	11	100	24.0	5.5	YHKC405P0600Z27+-000
6	32.0	24.5	15.0	27.5	-	0.8	30	11	100	18.5	7.5	YHKC605P0600Z27+-000
10	32.0	30.0	16.0	37.5	-	1.0	30	11	100	15.5	11.0	YHKC106P0600Z27+-000
18	32.0	37.0	22.0	37.5	-	1.0	30	11	100	8.5	15.0	YHKC186P0600Z27+-000
12	41.0	30.0	16.0	37.5	-	1.0	22	20	180	16.5	7.0	YHKC126P0600H37+-000
15	41.0	32.0	17.0	37.5	-	1.0	22	20	180	13.0	9.0	YHKC156P0600H37+-000
20	42.0	40.0	20.0	37.5	10.2	1.0	22	20	180	10.0	12.5	YHKC206P0600E3A+-000
25	42.0	40.0	20.0	37.5	10.2	1.0	22	20	180	8.0	15.5	YHKC256P0600E3A+-000
30	42.0	44.0	24.0	37.5	10.2	1.0	22	20	180	6.5	17.5	YHKC306P0600E3A+-000
35	42.0	45.0	30.0	37.5	20.3	1.2	22	25	200	6.0	20.0	YHKC356P0600E3C+-000
40	42.0	45.0	30.0	37.5	20.3	1.2	22	25	200	5.5	22.0	YHKC406P0600E3C+-000
50	42.0	46.0	35.0	37.5	20.3	1.2	22	25	200	4.5	25.0	YHKC506P0600E3C+-000
55	42.0	50.0	35.0	37.5	20.3	1.2	22	25	200	3.5	27.0	YHKC606P0600E3C+-000
60	57.5	45.0	30.0	52.5	20.3	1.2	22	30	360	4.0	22.0	YHKC606P0600E5C+-000
80	57.5	50.0	35.0	52.5	20.3	1.2	15	30	360	3.5	27.0	YHKC806P0600E5C+-000
110	57.5	55.0	45.0	52.5	20.3	1.2	15	30	360	3.0	29.0	YHKC117P0600E5C+-000

1 "+ -" Means the capacity tolerance can conform to "J"K

2 "000" Means Internal use the lead length

3 Capacitance value measured at 1 kHz

4 Max ripple current I_{RMS} at 85°C, at 10 kHz for a ΔT ≤15 °C at ΔESR_{typ} ≤±5%

5 Typical ESL value measured at resonance frequency

V _R =800Vdc at 85°C												
C (uF)	W ±1	H ±1	T ±1	P ±0.5	P2 ±0.5	d ±0.05	dV/dt (V/us)	T _g δ*10 ⁻⁴		ESR@10 kHz (mΩ)	I _{rms} (A)	Part number
								1kHz	10kHz			
2	32.0	18.0	9.0	27.5	-	0.8	40	10	95	45.0	2.5	YHKC205P0800Z27+-000
3	32.0	21.0	11.0	27.5	-	0.8	40	10	95	30.0	3.0	YHKC305P0800Z27+-000
5	32.0	24.5	15.0	27.5	-	0.8	40	10	95	18.0	6.5	YHKC505P0800Z27+-000
7	32.0	30.0	16.0	27.5	-	0.8	40	10	95	13.0	10.5	YHKC705P0800Z27+-000
12	32.0	37.0	22.0	27.5	-	1.0	40	10	95	7.5	12.0	YHKC126P0800Z27+-000
14	32.0	37.0	22.0	27.5	10.2	1.0	40	10	95	7.0	13.0	YHKC146P0800Z27K000
8	41.0	30.0	16.0	37.5	-	1.0	22	18	180	22.0	5.0	YHKC805P0800H37+-000
10	41.0	32.0	17.0	37.5	-	1.0	22	18	180	18.0	8.5	YHKC106P0800H37+-000
12	42.0	32.5	19.0	37.5	-	1.0	22	18	180	15.0	9.0	YHKC126P0800H37+-000
18	42.0	40.0	20.0	37.5	10.2	1.2	22	18	180	12.0	10.0	YHKC186P0800E3A+-000
20	42.0	40.0	20.0	37.5	10.2	1.2	22	18	180	12.0	12.0	YHKC206P0800E3A+-000
25	42.0	44.0	24.0	37.5	10.2	1.2	22	18	180	7.0	15.5	YHKC206P0800E3A+-000
30	42.0	45.0	30.0	37.5	20.3	1.2	22	18	180	6.5	18.5	YHKC306P0800E3C+-000
35	42.0	45.0	30.0	37.5	20.3	1.2	22	18	180	6.0	20.5	YHKC356P0800E3C+-000
40	42.0	46.0	35.0	37.5	20.3	1.2	22	18	180	5.5	22.0	YHKC406P0800E3C+-000
45	42.0	50.0	35.0	37.5	20.3	1.2	22	18	180	4.8	23.0	YHKC456P0800E3C+-000
50	57.5	45.0	30.0	52.5	20.3	1.2	15	33	320	8.0	18.0	YHKC506P0800E5C+-000
55	57.5	45.0	30.0	52.5	20.3	1.2	15	33	320	7.5	20.0	YHKC556P0800E5C+-000
60	57.5	50.0	35.0	52.5	20.3	1.2	15	33	320	6.5	22.0	YHKC606P0800E5C+-000
80	57.5	57.0	38.0	52.5	20.3	1.2	15	33	320	5.0	25.0	YHKC806P0800E5C+-000
90	57.5	55.0	45.0	52.5	20.3	1.2	15	33	320	4.5	26.0	YHKC906P0800E5C+-000

1 "+ -" Means the capacity tolerance can conform to "J"K

2 "000" Means Internal use the lead length

3 Capacitance value measured at 1 kHz

4 Max ripple current I_{RMS} at 85°C, at 10 kHz for a ΔT ≤15 °C at ΔESR_{typ} ≤±5%

5 Typical ESL value measured at resonance frequency

V _R =900Vdc at 85°C												
C(uF)	W ±1	H ±1	T ±1	P ±0.5	P2 ±0.5	d ±0.05	dV/dt (V/us)	T _g δ*10 ⁻⁴		ESR@10 kHz (mΩ)	I _{rms} (A)	Part number
								1kHz	10kHz			
1.5	32.0	18.0	9.0	27.5	-	0.8	50	9	90	85	1.5	YHKC155P0900Z27+-000
2.0	90	21.0	11.0	27.5	-	0.8	50	9	90	45	3.0	YHKC205P0900Z27+-000
4.0	32.0	24.5	15.0	27.5	-	0.8	50	9	90	21.5	6.0	YHKC405P0900Z27+-000
6.0	32.0	30.0	16.0	27.5	-	0.8	50	9	90	18.0	6.5	YHKC605P0900Z27+-000
10.0	32.0	37.0	22.0	27.5	-	1.0	50	9	90	12.0	12.5	YHKC106P0900Z27+-000
8	41.0	30.0	16.0	37.5	-	1.0	30	17	150	21	5.5	YHKC805P0900H37+-000
12	42.0	32.5	19.0	37.5	-	1.0	30	17	150	14.0	6.5	YHKC126P0900H37+-000
15	42.0	40.0	20.0	37.5	10.2	1.2	30	17	150	11.0	10.5	YHKC156P0900E3A+-000
20	42.0	44.0	24.0	37.5	10.2	1.2	30	17	150	8.5	15.0	YHKC206P0900E3A+-000
25	42.0	45.0	30.0	37.5	20.3	1.2	30	17	150	6.5	17.0	YHKC256P0900E3C+-000
28	42.0	45.0	30.0	37.5	20.3	1.2	30	17	150	6.0	18.0	YHKC286P0900E3C+-000
30	42.0	46.0	35.0	37.5	20.3	1.2	30	17	150	5.5	19.0	YHKC306P0900E3C+-000
35	42.0	50.0	35.0	37.5	20.3	1.2	30	17	150	5.0	21.0	YHKC356P0900E3C+-000
30	57.5	45.0	30.0	52.5	20.3	1.2	15	33	320	11.0	15.0	YHKC306P0900E5C+-000
35	57.5	45.0	30.0	52.5	20.3	1.2	15	33	320	9.5	12.5	YHKC356P0900E5C+-000
45	57.5	50.0	35.0	52.5	20.3	1.2	15	33	320	7.5	16.5	YHKC456P0900E5C+-000
60	57.5	57.0	38.0	52.5	20.3	1.2	15	33	320	5.6	22.0	YHKC606P0900E5C+-000
70	57.5	55.0	45.0	52.5	20.3	1.2	15	33	320	4.5	28.0	YHKC706P0900E5C+-000

1 "+ -" Means the capacity tolerance can conform to "J"~"K"

2 "000" Means Internal use the lead length

3 Capacitance value measured at 1 kHz

4 Max ripple current I_{RMS} at 85°C, at 10 kHz for a ΔT ≤15 °C at ΔESR_{typ} ≤±5%

5 Typical ESL value measured at resonance frequency

V _R =1000Vdc at 85°C												
C (uF)	W ±1	H ±1	T ±1	P ±0.5	P2 ±0.5	d ±0.05	dV/dt (V/us)	Tgδ*10 ⁻⁴		ESR@10 kHz (mΩ)	I _{rms} (A)	Part number
								1kHz	10kHz			
1.0	32.0	18.0	9.0	27.5	-	0.8	60	8	80	85	1.5	YHKC105P1000Z27+-000
1.5	32.0	21.0	11.0	27.5	-	0.8	60	8	80	45	3.0	YHKC155P1000Z27+-000
3.0	32.0	24.5	15.0	27.5	-	0.8	60	8	80	21.5	4.0	YHKC305P1000Z27+-000
4.5	32.0	30.0	16.0	27.5	-	0.8	60	8	80	18.0	5.5	YHKC455P1000Z27+-000
7.0	32.0	37.0	22.0	27.5	-	1.0	50	8	80	12.0	12.5	YHKC705P1000Z27+-000
6.0	41.0	30.0	16.0	37.5	-	1.0	60	15	140	21	5.5	YHKC605P1000H37+-000
8.0	42.0	32.5	19.0	37.5	-	1.0	40	15	140	14.0	6.5	YHKC805P1000H37+-000
10	42.0	40.0	20.0	37.5	10.2	1.0	40	15	140	11.0	10.5	YHKC106P1000E3A+-000
12	42.0	40.0	20.0	37.5	10.2	1.2	40	15	140	11.5	11.0	YHKC126P1000E3A+-000
15	42.0	44.0	24.0	37.5	10.2	1.2	40	15	140	8.5	15.0	YHKC156P1000E3A+-000
18	42.0	45.0	30.0	37.5	20.3	1.2	40	15	140	6.5	17.0	YHKC186P1000E3C+-000
20	42.0	45.0	30.0	37.5	20.3	1.2	40	15	140	6.0	18.0	YHKC206P1000E3C+-000
25	42.0	46.0	35.0	37.5	20.3	1.2	40	15	140	5.5	19.0	YHKC256P1000E3C+-000
25	57.5	45.0	30.0	52.5	20.3	1.2	20	28	280	11.0	15.0	YHKC256P1000E5C+-000
30	57.5	45.0	30.0	52.5	20.3	1.2	20	28	280	9.5	12.5	YHKC306P1000E5C+-000
35	57.5	50.0	35.0	52.5	20.3	1.2	20	28	280	7.5	16.5	YHKC356P1000E5C+-000
40	57.5	57.0	38.0	52.5	20.3	1.2	20	28	280	5.6	21.0	YHKC406P1000E5C+-000
55	57.5	55.0	45.0	52.5	20.3	1.2	20	28	280	4.5	28.0	YHKC556P1000E5C+-000

1 "+ -" Means the capacity tolerance can conform to "J"K

2 "000" Means Internal use the lead length

3 Capacitance value measured at 1 kHz

4 Max ripple current I_{RMS} at 85°C, at 10 kHz for a ΔT ≤15 °C at ΔESR_{typ} ≤±5%

5 Typical ESL value measured at resonance frequency

V _R =1100Vdc at 85°C												
C (uF)	W ±1	H ±1	T ±1	P ±0.5	P2 ±0.5	d ±0.05	dV/dt (V/us)	Tgδ*10 ⁻⁴		ESR@10 kHz (mΩ)	I _{rms} (A)	Part number
								1kHz	10kHz			
1.2	32	21.0	11.0	27.5	-	0.8	70	8	70	60	2.5	YHKC125P1100Z27+-000
2.5	32.0	24.5	15.0	27.5	-	0.8	70	8	70	25	4.5	YHKC255P1100Z27+-000
3.5	32.0	30.0	16.0	27.5	-	0.8	70	8	70	18	8.0	YHKC355P1100Z27+-000
5	32.0	37.0	22.0	27.5	-	1.0	70	8	70	15	10.5	YHKC505P1100Z27+-000
6	32.0	37.0	22.0	27.5	-	1.0	70	8	70	14.5	12.5	YHKC605P1100Z27+-000
4.5	41.0	30.0	16.0	37.5	-	1.0	45	15	130	30.5	4.0	YHKC455P1100H37+-000
7	42.0	32.5	19.0	37.5	-	1.0	45	15	130	21.0	7.0	YHKC705P1100H37+-000
8	42.0	40.0	20.0	37.5	10.2	1.0	45	15	130	18.0	8.5	YHKC805P1100E3A+-000
10	42.0	40.0	20.0	37.5	10.2	1.0	45	15	130	14.5	11.0	YHKC106P1100E3A+-000
12	42.0	44.0	24.0	37.5	10.2	1.0	45	15	130	12.0	12.5	YHKC126P1100E3A+-000
15	42.0	45.0	30.0	37.5	20.3	1.2	45	15	130	10.0	14.0	YHKC156P1100E3C+-000
17	42.0	45.0	30.0	37.5	20.3	1.2	45	15	130	8.0	17.0	YHKC176P1100E3C+-000
20	42.0	46.0	35.0	37.5	20.3	1.2	45	15	130	7.0	18.0	YHKC206P1100E3C+-000
22	42.0	50.0	35.0	37.5	20.3	1.2	45	15	130	6.5	16.0	YHKC226P1100E3C+-000
20	57.5	45.0	30.0	52.5	20.3	1.2	25	27	260	15.0	15.5	YHKC206P1100E5C+-000
25	57.5	45.0	30.0	52.5	20.3	1.2	25	27	260	11.0	18.5	YHKC256P1100E5C+-000
30	57.5	50.0	35.0	52.5	20.3	1.2	25	27	260	9.5	19.5	YHKC306P1100E5C+-000
35	57.5	57.0	38.0	52.5	20.3	1.2	25	27	260	8.5	20.5	YHKC356P1100E5C+-000
45	57.5	55.0	45.0	52.5	20.3	1.2	25	27	260	7.0	22.0	YHKC456P1100E5C+-000

1 "+ -" Means the capacity tolerance can conform to "J"K

2 "000" Means Internal use the lead length

3 Capacitance value measured at 1 kHz

4 Max ripple current I_{RMS} at 85°C, at 10 kHz for a ΔT ≤15 °C at ΔESR_{typ} ≤±5%

5 Typical ESL value measured at resonance frequency

V _R =1200Vdc at 85°C												
C (uF)	W ±1	H ±1	T ±1	P ±0.5	P2 ±0.5	d ±0.05	dV/dt (V/us)	Tgδ*10 ⁻⁴		ESR@10 kHz (mΩ)	I _{rms} (A)	Part number
								1kHz	10kHz			
1.0	32	21.0	11.0	27.5	-	0.8	80	7	55	40.0	3.5	YHKC105P1200Z27+-000
2.0	32.0	24.5	15.0	27.5	-	0.8	80	7	55	26.5	4.0	YHKC205P1200Z27+-000
3.0	32.0	30.0	16.0	27.5	-	0.8	80	7	55	17.5	6.5	YHKC325P1200Z27+-000
5.0	32.0	37.0	22.0	27.5	-	1.0	80	7	55	11.0	9.5	YHKC505P1200Z27+-000
4.0	41.0	30.0	16.0	37.5	-	1.0	50	13	100	37.5	3.5	YHKC405P1200H37+-000
6.0	42.0	32.5	19.0	37.5	-	1.0	50	13	100	18.5	6.5	YHKC605P1200H37+-000
7.0	42.0	40.0	20.0	37.5	10.2	1.0	50	13	100	16.0	9.5	YHKC705P1200E3A+-000
8.0	42.0	40.0	20.0	37.5	10.2	1.0	50	13	100	14.0	10.5	YHKC805P1200E3A+-000
10.0	42.0	44.0	24.0	37.5	10.2	1.0	50	13	100	11.0	12.0	YHKC106P1200E3A+-000
12.0	42.0	45.0	30.0	37.5	20.3	1.2	50	13	100	9.5	13.0	YHKC126P1200E3C+-000
14.0	42.0	45.0	30.0	37.5	20.3	1.2	50	13	100	7.5	16.0	YHKC146P1200E3C+-000
16.0	42.0	46.0	35.0	37.5	20.3	1.2	50	13	100	6.5	18.0	YHKC166P1200E3C+-000
18.0	42.0	50.0	35.0	37.5	20.3	1.2	50	13	100	6.0	20.0	YHKC186P1200E3C+-000
18.0	57.5	45.0	30.0	52.5	20.3	1.2	30	25	240	10.5	15.0	YHKC186P1200E5C+-000
20.0	57.5	45.0	30.0	52.5	20.3	1.2	30	25	240	11.0	16.0	YHKC206P1200E5C+-000
25.0	57.5	50.0	35.0	52.5	20.3	1.2	30	25	240	9.5	18.5	YHKC256P1200E5C+-000
30.0	57.5	57.0	38.0	52.5	20.3	1.2	30	25	240	8.0	20.0	YHKC306P1200E5C+-000
38.0	57.5	55.0	45.0	52.5	20.3	1.2	30	25	240	5.5	22.0	YHKC386P1200E5C+-000

1 "+ -" Means the capacity tolerance can conform to "J""K

2 "000" Means Internal use the lead length

3 Capacitance value measured at 1 kHz

4 Max ripple current I_{RMS} at 85°C, at 10 kHz for a ΔT ≤15 °C at ΔESR_{typ} ≤±5%

5 Typical ESL value measured at resonance frequency

◆ Curves Characteristics (I_{RMS} derating vs temperature)

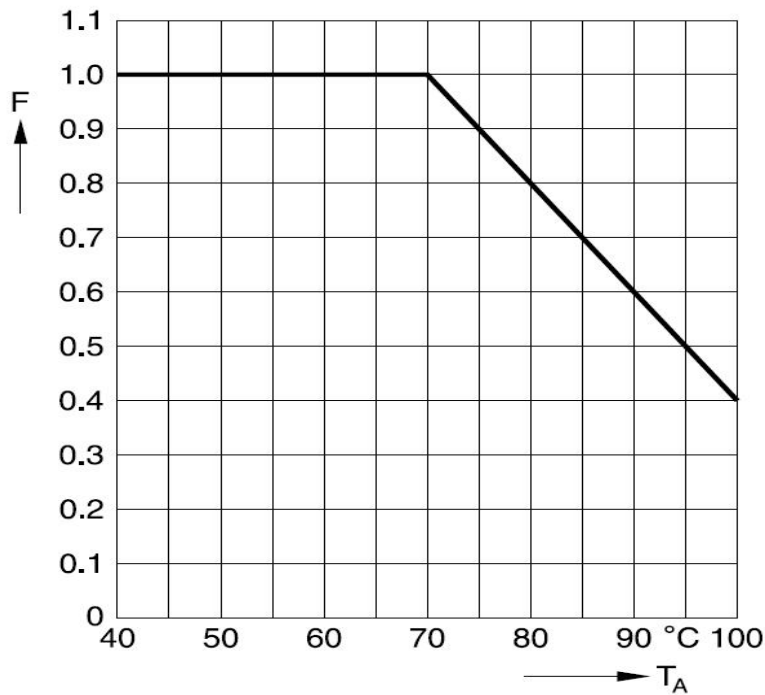

Maximum I_{RMS} current as function of the ambient temperature: I_{RMS} (T_A) = Factor x I_{RMS} (70°C)

◆ Life time expectancy - typical curve

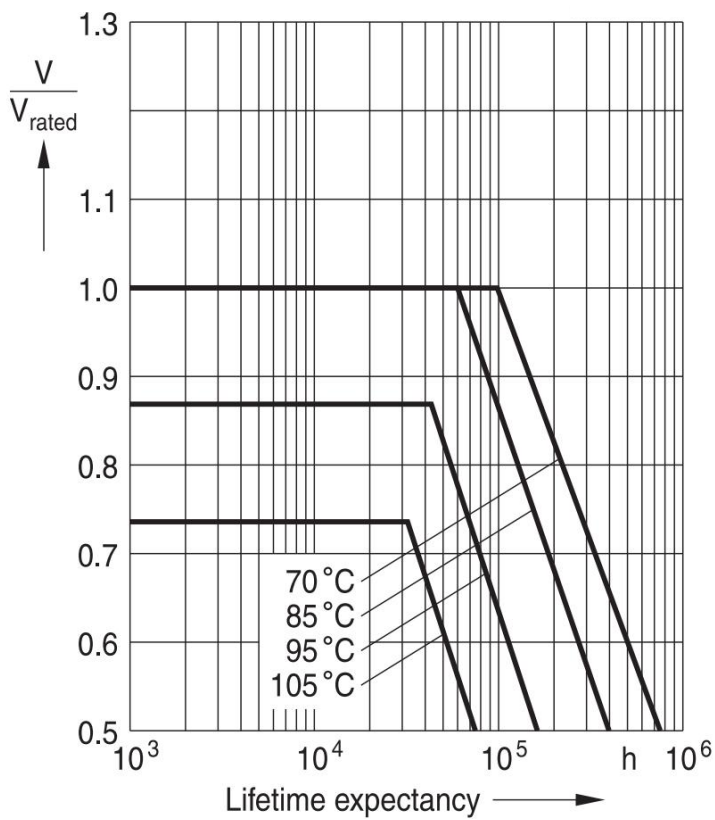

Note: Confidence level of 95%

◆ Impedance Z vs frequency f - typical values

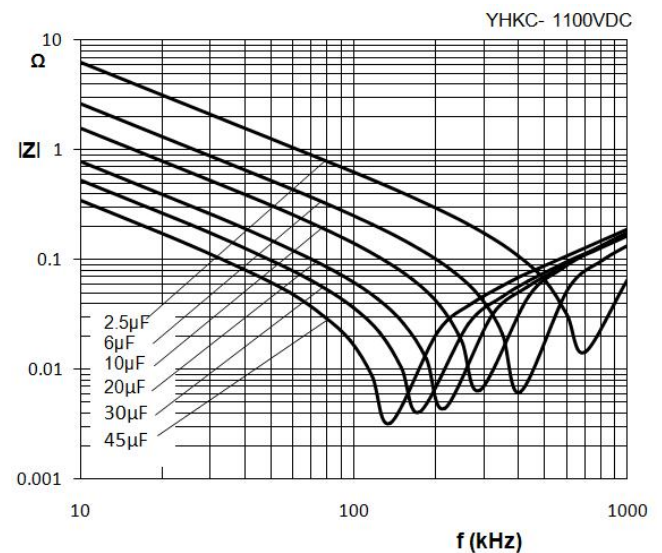
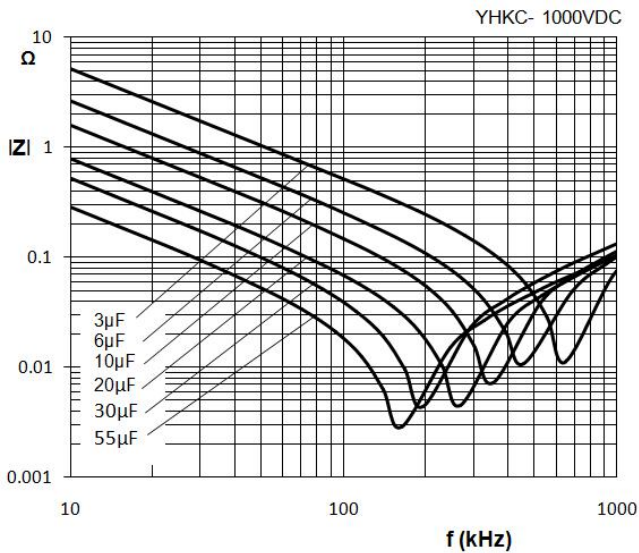
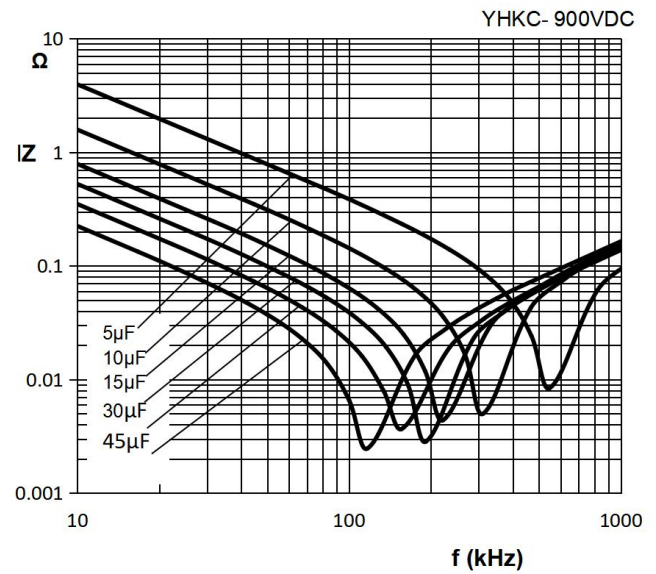
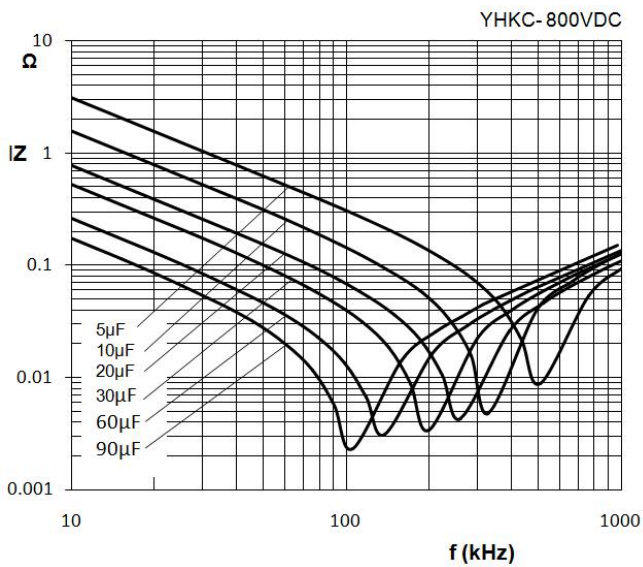
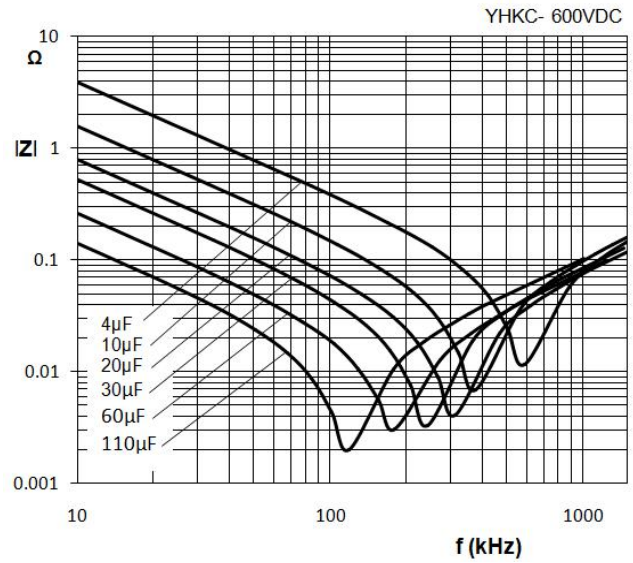
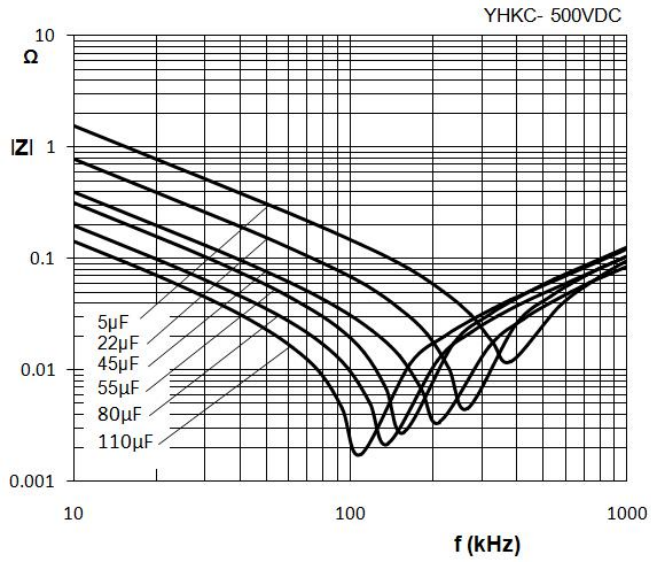

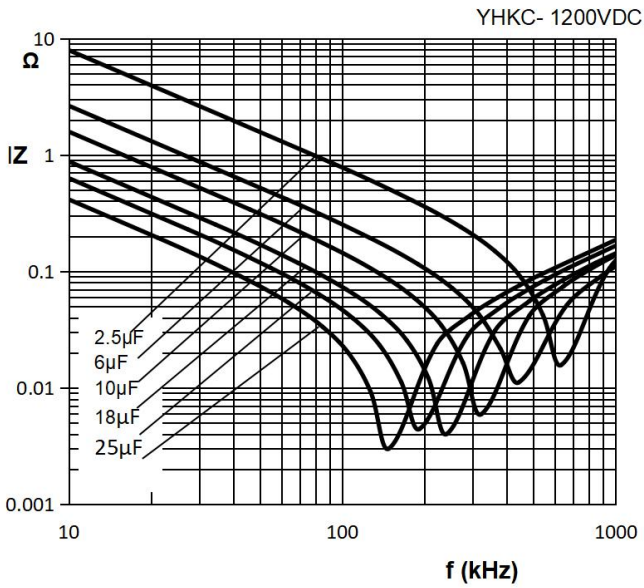

◆ ESR vs frequency f - typical values

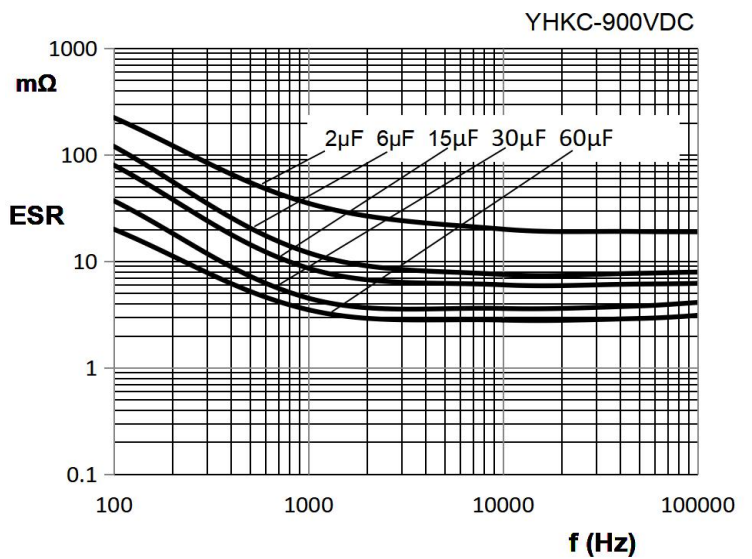
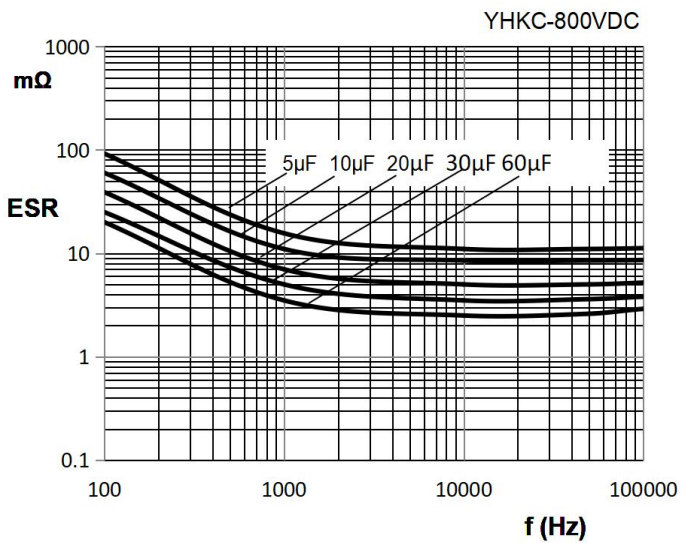
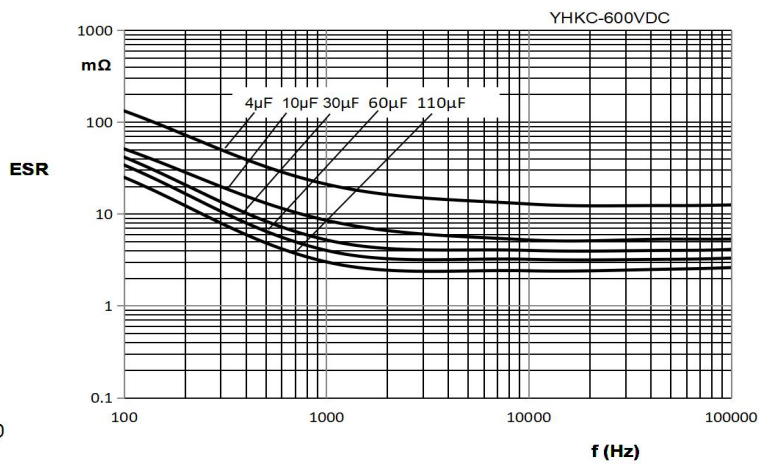
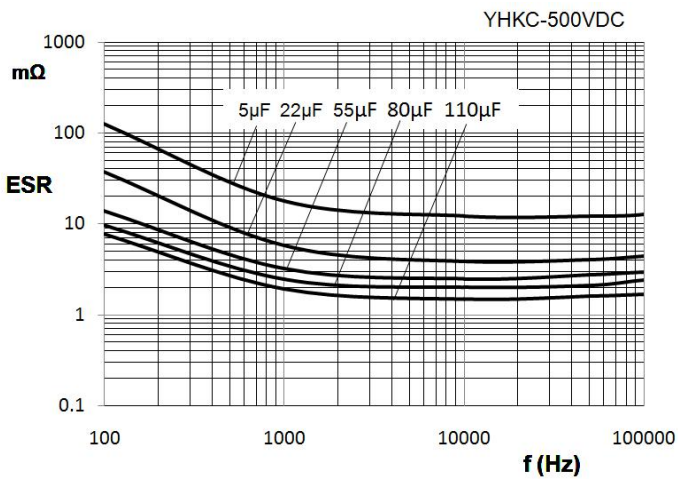

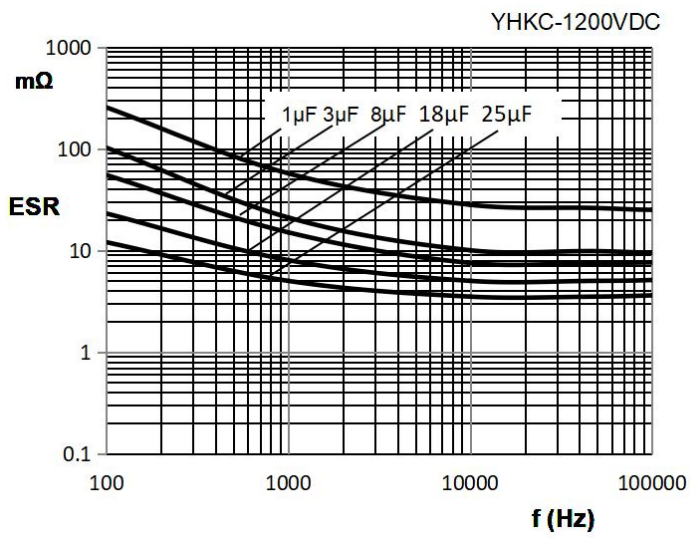
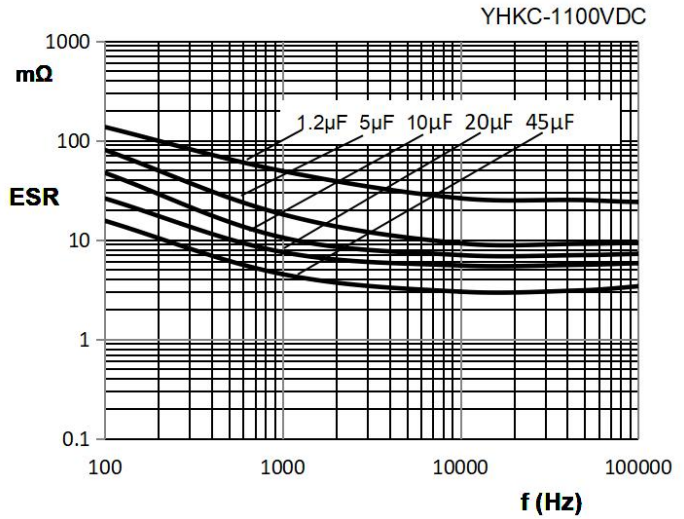
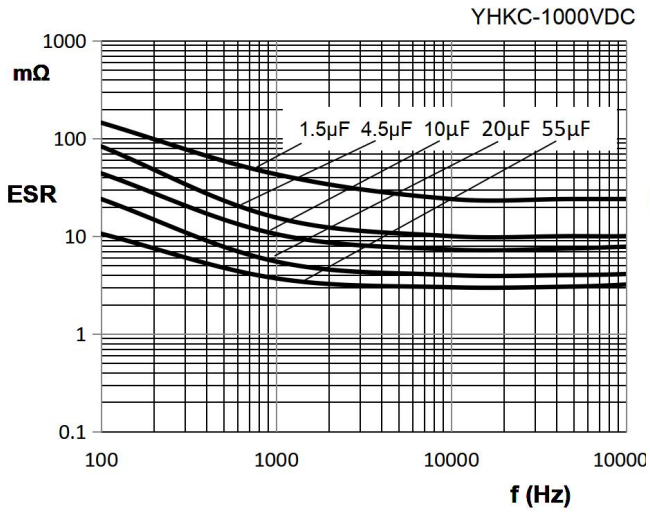

◆ **Irms versus frequency f - typical values**

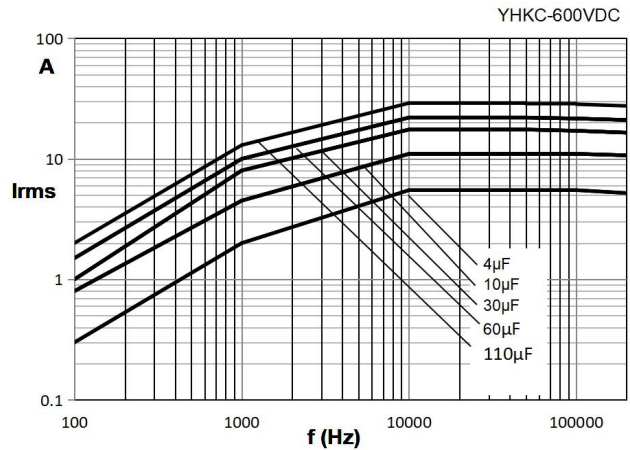
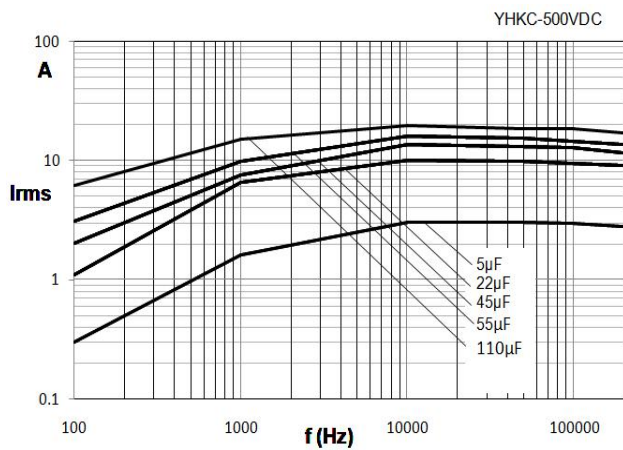

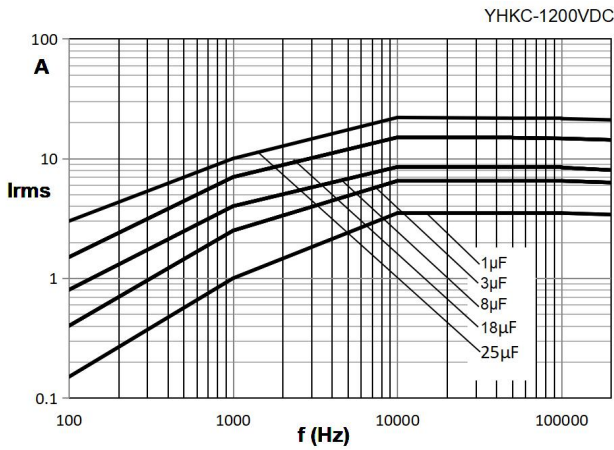
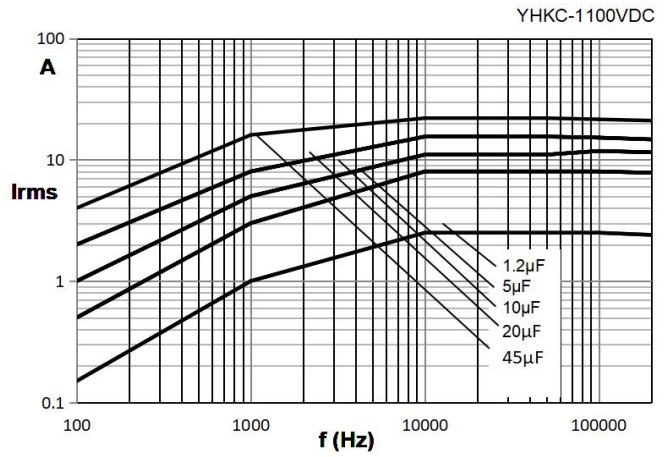
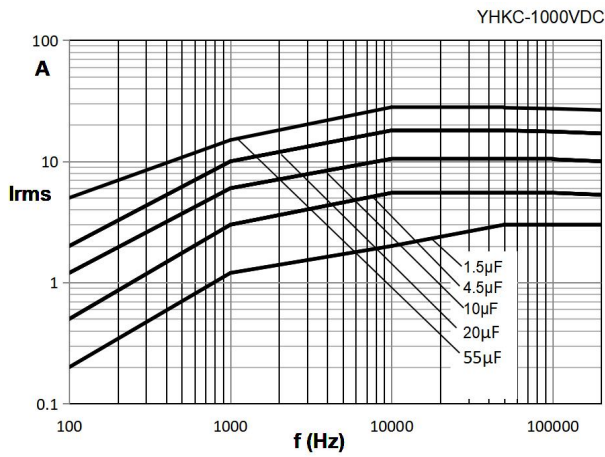
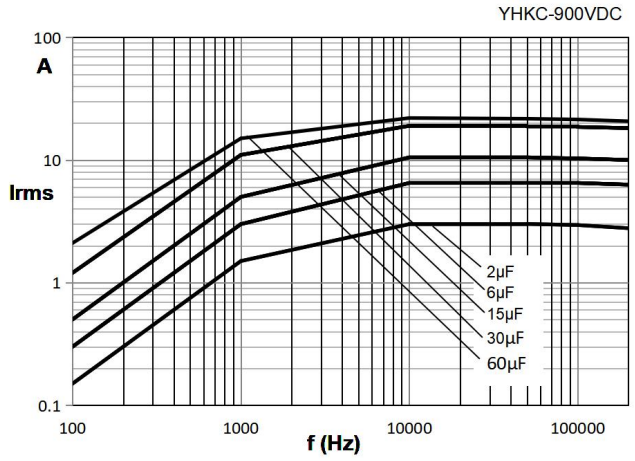
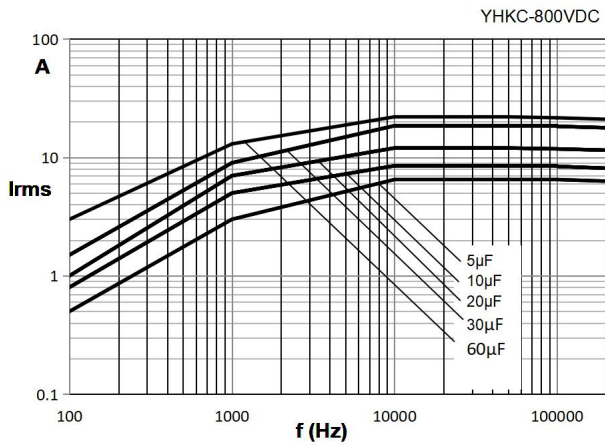

◆ **Testing and Standards**

Test project	Conditions of test	Performance requirements
Appearance inspection	Visual inspection	No visible damage. Mark clear
Dimensional check	Vernier caliper	Comply with the specification limits
DC voltage test between terminals and terminals	1.5xU _N 60S	Capacitance and tan d within specified limits
AC voltage test between terminals and case	2100Vac*60s,50Hz	Capacitance and tan d within specified limits
Capacitance test	20±10°C,1kHz	Comply with the specification limits
Tangent of loss Angle	20±10°C,1kHz	Comply with the specification limits
Inter electrode insulation resistance	20±10°C,100v,60S	Comply with the specification limits
ESR	20±10°C,10kHz	Comply with the specification limits
ESL	Measured at resonant frequency	Comply with the specification limits
Robustness of terminations	Tensile strength (test Ua1) Wire diameter sectional area tensile force d ≤ 0.8 mm ≤ 0.5mm ² 10N 0.8 < d ≤ 1.25 mm ≤ 1.2mm ² 20N Bending (test Ub1) Wire diameter Cross section modulus tensile force d ≤ 0.8 mm 0.05mm ³ 10N 0.8 < d ≤ 1.25 mm 0.169mm ³ 320N	No visible damage ΔC/C0 ≤ 0.5% 1kHz Tanδ Increase ≤ 0.005 10kHz
Welding heat resistant	Groove welding Tb, methods 1A 260°C±5°C, 2±0.5s, depth distance leads to the root, 1.5~2mm	No visible damage DC/C0 ≤ 0.5% 1kHz Tanδ Increase ≤ 0.005 10kHz
Weldability	Groove welding Tb, methods 1A 235°C±5°C, 2±0.5s, depth distance leads to the root, 1.5~2mm	No visible damage DC/C0 ≤ 0.5% 1kHz Tanδ Increase ≤ 0.005 10kHz
Vibration	Test FC: vibration sinusoidal	No visible damage

	<p>Displacement: 0.35mm</p> <p>Acceleration: 98 m/s²</p> <p>Frequency: 10Hz ... 55Hz</p> <p>Frequency sweep cycles:10 times</p> <p>Test duration: Take three mutually perpendicular directions, each with a duration of 10 frequency cycles, One octave per minute</p>	<p> $\Delta C/C_0$ $\leq 0.5\%$ 1kHz</p> <p>Tanδ Increase ≤ 0.005 10kHz</p>
Mechanical shock	<p>Impact pulse pattern:A half sine wave</p> <p>Acceleration:490m/s²</p> <p>duration time:11ms</p>	<p>No visible damage</p> <p> $\Delta C/C_0$ $\leq 0.5\%$ 1kHz</p> <p>Tanδ Increase ≤ 0.005 10kHz</p> <p> $\Delta C/C_0$ $\leq 0.5\%$ 1kHz</p>
Impact discharge test	<p>5 times in 10 minutes</p> <p>Test voltage:1.1xU_N</p> <p>Test current:1.1 Maximum impulse current</p>	<p>No permanent breakdown or flash-over</p> <p> $\Delta C/C_0$ $\leq 1.0\%$ 1kHz</p> <p>$\Delta \tan\delta \leq 1.2 \times \tan\delta + 0.0001$ 10kHz</p>
temperature change	<p>Test Nb</p> <p>Tmin=-40°C Tmax=+85°C</p> <p>Rate of temperature change: 1°C/min</p> <p>5 cycles, duration: 30min</p>	<p>No visible damage</p> <p> $\Delta C/C_0$ $\leq 2.0\%$ 1kHz</p> <p>Tanδ Increase ≤ 0.015 10kHz</p> <p>Insulation resistance Rins$\geq 50\%$ of initial limit</p> <p> $\Delta C/C_0$ $\leq 2.0\%$ 1kHz</p>
High temperature storage	<p>Ceiling temperature, 48h</p>	<p>No visible damage</p> <p> $\Delta C/C_0$ $\leq 2.0\%$ 1kHz</p> <p>Tanδ Increase ≤ 0.015 10kHz</p> <p> $\Delta C/C_0$ $\leq 2.0\%$ 1kHz</p>
Low temperature storage	<p>Lower limit temperature, 48h</p>	<p>No visible damage</p> <p> $\Delta C/C_0$ $\leq 2.0\%$ 1kHz</p> <p>Tanδ Increase ≤ 0.015 10kHz</p> <p> $\Delta C/C_0$ $\leq 2.0\%$ 1kHz</p>

Self-Healing	<p>$U_{test} = 1,5xU_N, 10s.$</p> <p>If fewer than five clearings occur during this time, the voltage shall be increased slowly until five clearings have occurred since the start of the test or until the voltage has reached 2,5 times the rated voltage</p>	<p>No visible damage</p> <p>$DC/C_0 \leq 0.5\%$ 1kHz</p> <p>$\Delta \tan \delta \leq 1.2 \times \tan \delta + 0.0001$ 10kHz</p> <p>RINS $\geq 50\%$ of initial limit</p>
Damp heat test	<p>$40 \pm 2^\circ C$</p> <p>93% $\pm 3RH$</p> <p>56 days</p>	<p>No visible damage</p> <p>$\Delta C/C_0 \leq 2.0\%$ 1kHz</p> <p>Tanδ Increase ≤ 0.015 10kHz</p> <p>Insulation resistance Rins $\geq 50\%$ of initial limit</p>
thermal stability	<p>Test temperature: $85^\circ C$</p> <p>Test current: I_{max}</p> <p>Test frequency: 10kHz</p> <p>Duration time: 48h or Until the temperature rises steadily</p>	<p>surface temperature rise $\Delta T \leq 15^\circ C$</p> <p>$\Delta C/C_0 \leq 2.0\%$ 1kHz</p> <p>Tanδ Increase ≤ 0.015 10kHz</p> <p>Insulation resistance Rins $\geq 50\%$ of initial limit</p>
Endurance test	<p>$85^\circ C, 1.3U_N$ 500h hours</p> <p>and 1000 discharges at 1.4 peak current</p> <p>and $85^\circ C, 1.3U_N,$ 500 hours</p>	<p>No visible damage</p> <p>$\Delta C/C_0 \leq 3.0\%$ 1kHz</p> <p>Tanδ Increase ≤ 0.015 10kHz</p> <p>Insulation resistance Rins $\geq 50\%$ of initial limit</p>
Biased humidity test	<p>Test temperature: $60 \pm 3^\circ C$</p> <p>Test humidity: $95 \pm 3\%RH$</p> <p>Test voltage: $1.0 U_N$</p> <p>Duration time: 1000 hours</p>	<p>No visible damage</p> <p>$\Delta C/C_0 \leq 5.0\%$ 1kHz</p> <p>Tanδ Increase ≤ 0.015 10kHz</p> <p>Insulation resistance Rins $\geq 50\%$ of initial limit</p>

◆ **Soldering**

Solderability of leads

The solderability of terminal leads is tested to IEC 60068-2-20:2008, test Ta, method 1

Before a solderability test is carried out, terminals are subjected to accelerated ageing (to IEC 60068-2-2:2007, test Ba: 4 h exposure to dry heat at 155 °C). Since the ageing temperature is far higher than the upper category temperature of the capacitors, the terminal wires should be cut off from the capacitor before the ageing procedure to prevent the solderability being impaired by the products of any capacitor decomposition that might

Solder bath temperature	235 ±5 °C
Soldering time	2.0 ±0.5 s
Immersion depth	2.0 +0/0.5 mm from capacitor body or seating plane
Evaluation criteria: Visual inspection	Wetting of wire surface by new solder ≥90%, free flowing solder

◆ **Packing**

The part number, quantity, date of manufacture, manufacturer and factory inspection stamp are indicated on the packing box

Different batches of the same product shall not be placed in the same box6.2

After the arrival of the goods the customer side, packing seals should be intact, the box without damage, cracks and other phenomena;

The capacitor is fixed with a plastic foam board and should be shockproof and shockproof.

◆ **Packing Mark**

For example:

Product Label			
Supplier Code	1.11236P0450H27J050		
Description	DC-Filter Capacitor		
Type	YHKC		
Quantity	500PCS		
Date	2020.12	Batch No.	L1201003
Supplier	Ningguo Yuhua		